

LED导光柱 LED PIPE

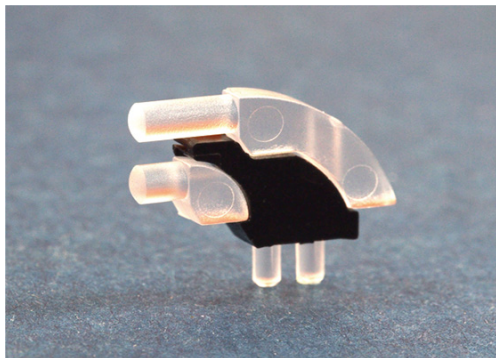

用途：使LED导光于机壳面板上，使光度均匀、柔和。

MATERIAL : PC(UL)

FLAME CLASS : 94V-0,94V-2

COLOR : TRANSPARENT

UNIT : mm

2

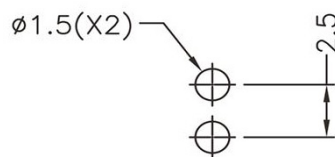
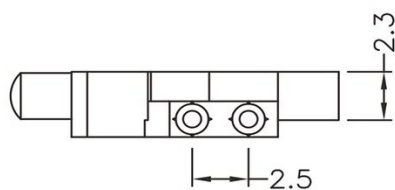
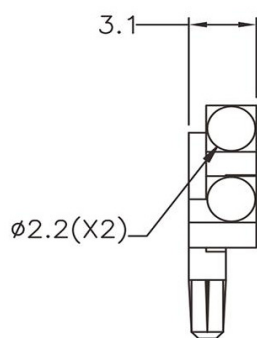
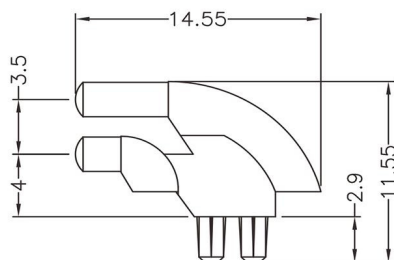

MOUNTING HOLE

LED导光柱 - 遮光罩

遮蔽导光柱，避免邻近LED光线干扰，配合LEDLP-172使用

MATERIAL : NYLON 66(UL)

FLAME CLASS : 94V-0,94V-2

COLOR : BLACK,NATURAL

UNIT : mm

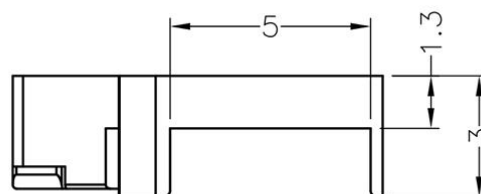
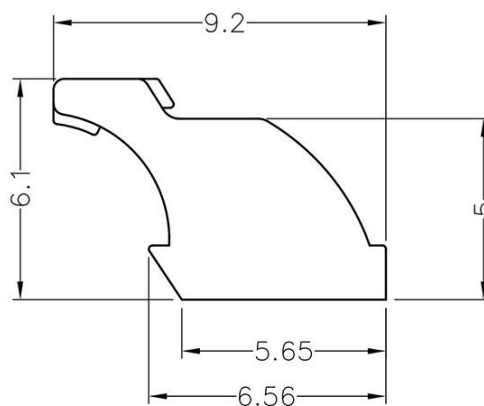

PART NO	PACKAGE
LEDLP-172	1000

PART NO	PACKAGE
LEDLP-173	1000